

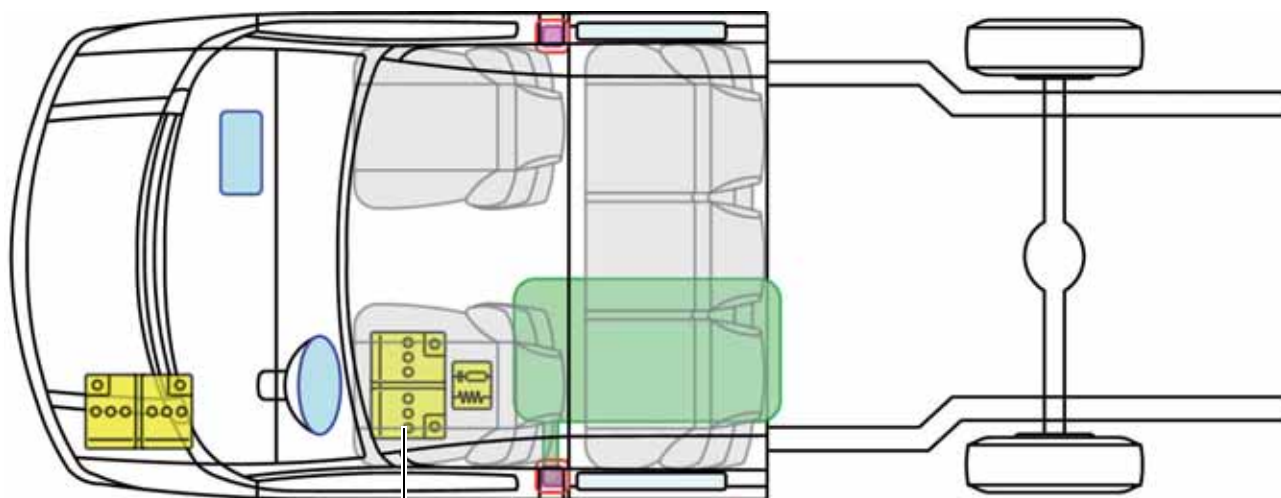

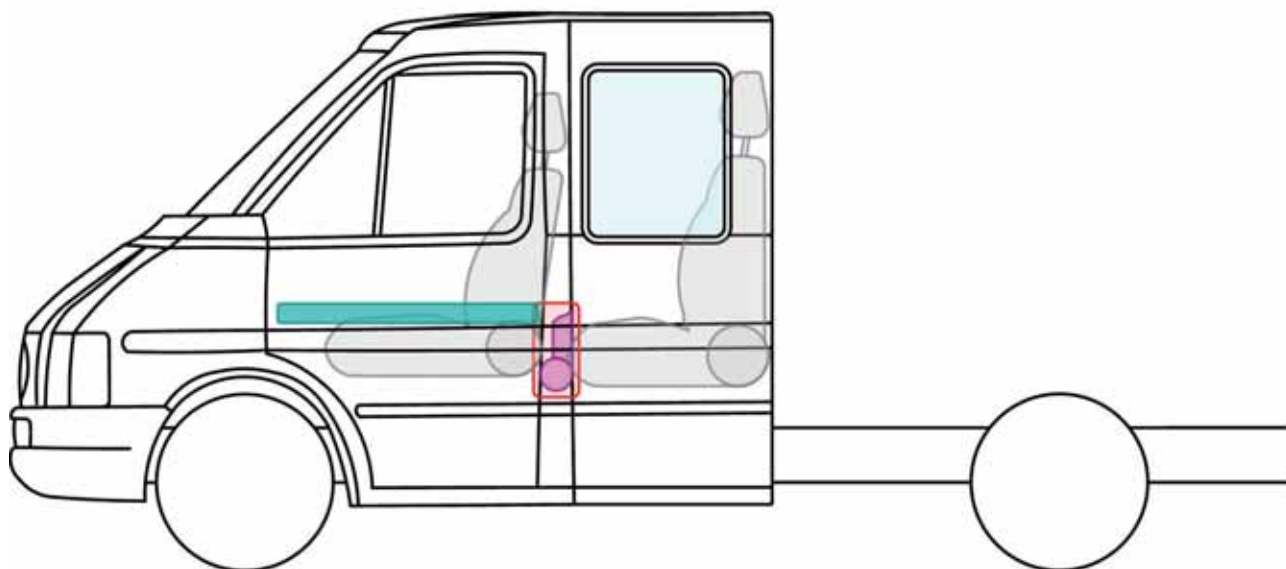





LT2 podwozie do zabudowy (4-drzwiowy, od 1996)



w zależności od wyposażenia dodatkowy akumulator pod siedzeniem kierowcy



Legenda

	Poduszka powietrzna		Wzmocnienie nadwozia		Sterownik	
					Akumulator 12 V	
	Napinacz pasa bezpieczeństwa				Zbiornik paliwa	